

# AS1



## AREASCAN™ HIGH-RESOLUTION DETECTION PHOTOELECTRIC LIGHT GRIDS

- Crossed beam area sensors
- 100mm controlled height
- Adjustment trimmer
- Optical or wire synchronism
- Scan Mode input

### APPLICATIONS

- Processing lines
- Food, Cosmetic and Pharmaceutical
- Electronics and mechanical assembling
- Conveyor lines and sorting systems



AS1	
<b>Area sensing</b>	100 mm
<b>Operating Distance</b>	0,3...2,1 m (AS1-LD) 0,8...3 m (AS1-HD)
<b>Resolution</b>	Flat: 0,2x75mm Cylindrical: Ø 6mm (AS1-HR) Flat: 0,2x200mm Cylindrical: Ø18mm (AS1-SR)
<b>Response Time</b>	1,75 ms (AS1-SR) 2,75...8 ms (AS1-HR)
<b>Light emission</b>	IR LED
<b>Power supply</b>	Vdc 24 V Vac Vac/dc
<b>Output</b>	PNP • NPN NPN/PNP relay other
<b>Connection</b>	cable connector • pig-tail
<b>Approximate dimensions (mm)</b>	22x43x150
<b>Housing material</b>	aluminium
<b>Mechanical protection</b>	IP65

# TECHNICAL DATA

<b>Power supply</b>	24 Vdc $\pm$ 15%
<b>Consumption on emitter unit (TX)</b>	150 mA max.
<b>Consumption on receiver unit (RX)</b>	40 mA max. load excluded
<b>Light emission</b>	IR LED 880 nm
<b>Setting</b>	adjustment trimmer (mod. AS1...P)
<b>Indicators</b>	yellow OUTPUT LED green POWER ON LED
<b>Output</b>	PNP
<b>Output current</b>	100 mA max.
<b>Saturation voltage</b>	1,5 V max.
<b>Response time</b>	2,75 - 8 ms (mod. AS1-HR) 1,75 ms (mod. AS1-SR)
<b>Connection</b>	M12 4-pole connector (TX), M12 5-pole connector (RX)
<b>Dielectric strength</b>	500 Vac, 1 min between electronics and housing
<b>Insulating resistance</b>	>20 M $\Omega$ , 500 Vdc between electronics and housing
<b>Mechanical protection</b>	IP65 (EN 60529)
<b>Vibrations</b>	0,5 mm amplitude, 10 ... 55 Hz frequency, for every axis (EN60068-2-6)
<b>Shock resistance</b>	11 ms (30 G) 6 shock for every axis (EN60068-2-27)
<b>Housing material</b>	black electro-painted aluminium
<b>Lens material</b>	PMMA
<b>Operating temperature</b>	0 ... 50 °C
<b>Storage temperature</b>	-25 ... 70 °C
<b>Weight</b>	300 g

# DIMENSIONS

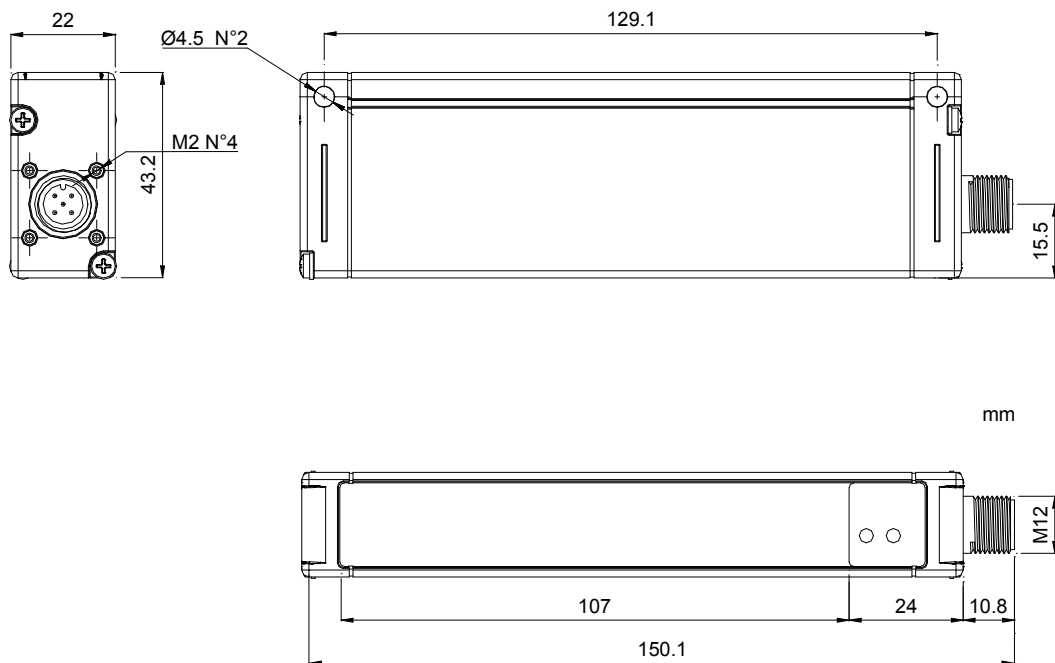

# INDICATORS AND SETTINGS

Two different models are available: high resolution (AS1-HR) or standard resolution (AS1-SR). In the first case the light array has 16 beams, while in the second case the beams are reduced to 6. In the AS1-HR model, the selection inputs of the SCAN MODE, can configure 4 different crossed-beam scanning modes. These different modes allow to vary the detection performances, in particular the resolution can be increased to 0.2mm thickness, or the response time up to less than 3ms.

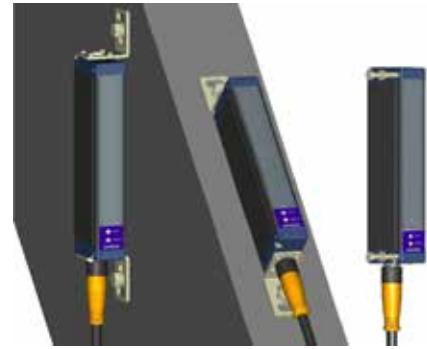

## INDICATORS AND SETTINGS (TRIMMER VERSION)

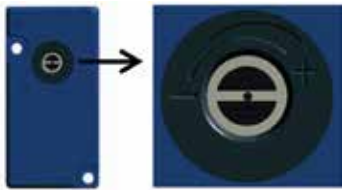

Emitter is equipped with a manual regulation which lets the user change the emission power by means of a screwdriver. The emission power reduction can be particularly useful to lower passive reflections when maximum operating distance it is not required.

## CONNECTIONS

### M12 CONNECTOR

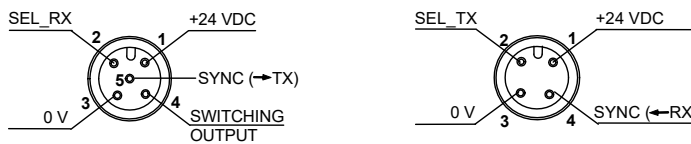

		AS1-HR	AS1-SR			AS1-HR	AS1-SR
<b>RECEIVER (RX):</b> M12 5-pole connector	1 – brown:	+24 VDC	+24 VDC	<b>EMITTER (TX):</b> M12 4-pole connector	1 – brown:	+24 VDC	+24 VDC
	2 – white:	SEL_RX	Not used		2 – white:	SEL_TX	Not used
	3 – blue:	0 V	0 V		3 – blue:	0 V	0 V
	4 – black:	Switching output	Switching output		4 – black:	SYNC **	SYNC *
	5 – grey:	SYNC*	SYNC*				

\* not used in trimmer version  
\*\* SEL\_TX2 in trimmer version

## HIGH RESOLUTION SCANNING MODE

PROG. N°	SEL_RX	SEL_TX	RESOLUTION	RESPONSE TIME (msec )
1	0 Vdc or FLOAT	0 Vdc or FLOAT	LOW	2.75
2	0 Vdc or FLOAT	24 Vdc	M/L	3
3	24 Vdc	0Vdc or FLOAT	M/H	7.75
4	24 Vdc	24 Vdc	HIGH	8

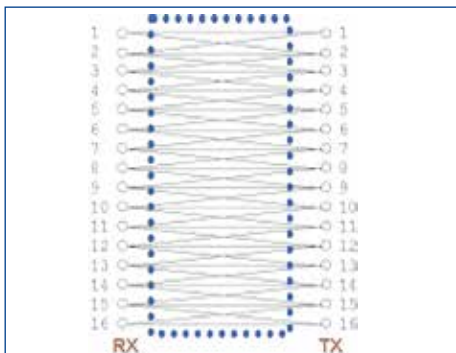

**Scan mode 1:**  
high speed / low resolution  
Minimum object detection  
Flat = 0.4 (thickness) x 100 (width) mm  
Cylindrical objects = Ø 6 mm

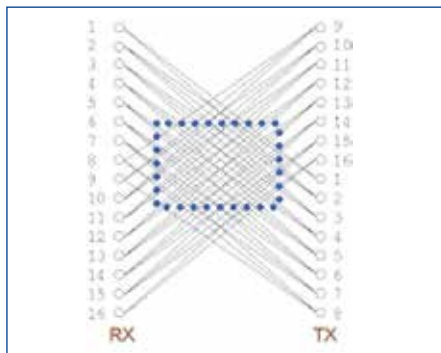

**Scan mode 2:**  
high speed / mid resol. central area  
Minimum object detection  
Flat = 0.4 (thickness) x 90 (width) mm  
Cylindrical objects = Ø 6 mm

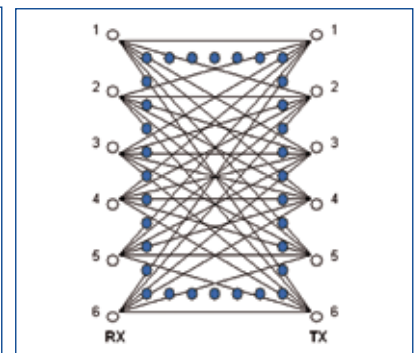

**Scan mode 3-4:**  
low speed / high resolution  
Minimum object detection  
Flat = 0.2 (thickness) x 75 (width) mm  
Cylindrical objects = Ø 6 mm

# STANDARD RESOLUTION SCANNING MODE

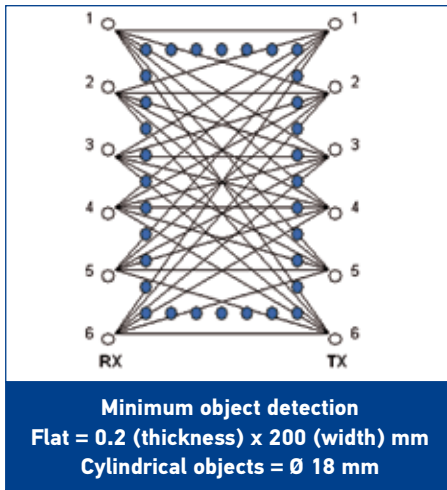

Note: the scan mode is fixed in the standard resolution version.

## MODEL SELECTION AND ORDER INFORMATION

OPTIC FUNCTION	OPERATING DISTANCE	RESOLUTION	SETTING	MODEL	ORDER No.
Area sensor	2 m	High	n/a	AS1-LD-HR-010-J	958101000
			Adjustment Trimmer	AS1-LD-HR-010-P	958101040
		Standard	n/a	AS1-LD-SR-010-J	958101010
			Adjustment Trimmer	AS1-LD-SR-010-P	958101050
	3 m	High	n/a	AS1-HD-HR-010-J	958101020
		Standard		AS1-HD-SR-010-J	958101030

## CABLES

TYPE	DESCRIPTION	LENGTH	MODEL	ORDER No.
Axial M12 Connector	4-pole, grey, P.V.C.	3 m	CS-A1-02-G-03	95A251380
		5 m	CS-A1-02-G-05	95A251270
		10 m	CS-A1-02-G-10	95A251390
	4-pole, U.L., black, P.V.C.	3 m	CS-A1-02-U-03	95ASE1120
		5 m	CS-A1-02-U-05	95ASE1130
		10 m	CS-A1-02-U-10	95ASE1140
		15 m	CS-A1-02-U-15	95ASE1150
		25 m	CS-A1-02-U-25	95ASE1160
	5-pole, grey, P.V.C.	3 m	CS-A1-03-G-03	95ACC2110
		5 m	CS-A1-03-G-05	95ACC2120
		10 m	CS-A1-03-G-10	95ACC2140
	5-pole, U.L., black, P.V.C.	3 m	CS-A1-03-U-03	95ASE1170
		5 m	CS-A1-03-U-05	95ASE1180
		10 m	CS-A1-03-U-10	95ASE1190
		15 m	CS-A1-03-U-15	95ASE1200
		25 m	CS-A1-03-U-25	95ASE1210
		50 m	CS-A1-03-U-50	95A252700